

REVISION HISTORY			
REV	DESCRIPTION	DATE	APPROVED
0	New Issue	23/02/2016	F. Foley

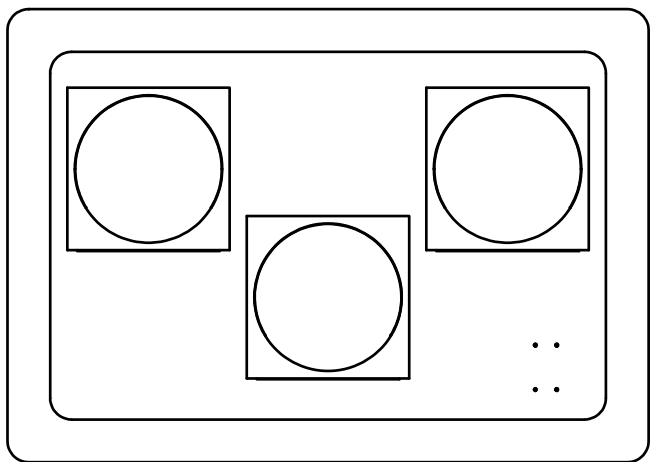

2

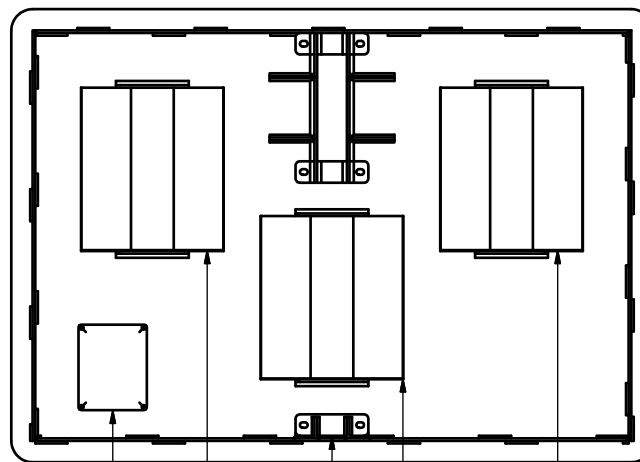
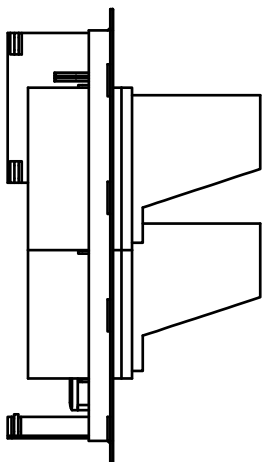

5

3

1

4

3

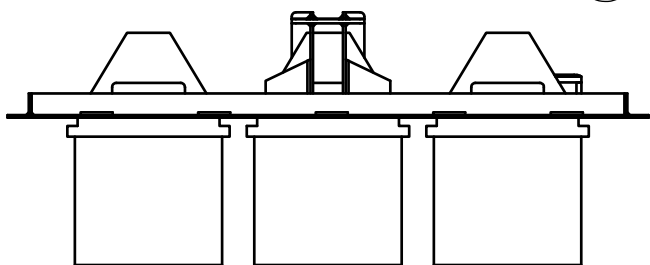

Part #: 151A0121
 Description: Standard Road Traffic Lights Assembly
 Tolerance: ±0.5mm

Designed by F. Foley	Checked by G. O'Connell	Approved by F. Foley	Date 23/02/2016	Date 23/02/2016
			Standard Road Traffic Lights Assembly	
			Drawing Number 151A0121D	Edition 0

PARTS LIST				
ITEM	QTY	STOCK NUMBER	TITLE	
1	1	151W0010	Tacse Type Faceplate Welded	
2	1	51P1020	Reflective Tape	
3	2	27H324-SR	Tacse 300mm Red LED Light	
4	1	27H324-SA	Tacse 300mm Amber LED Light	
5	1	16EL35950	Enclosure, PVC 180x140x80, Legrand 35950	

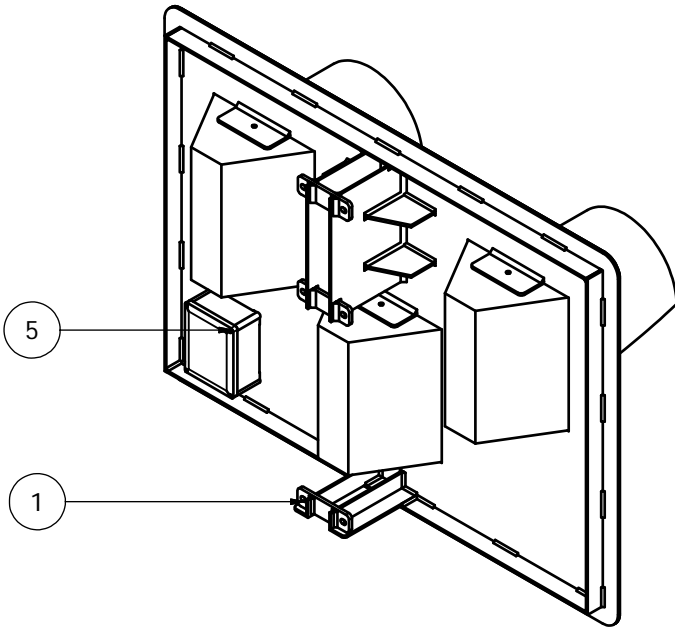
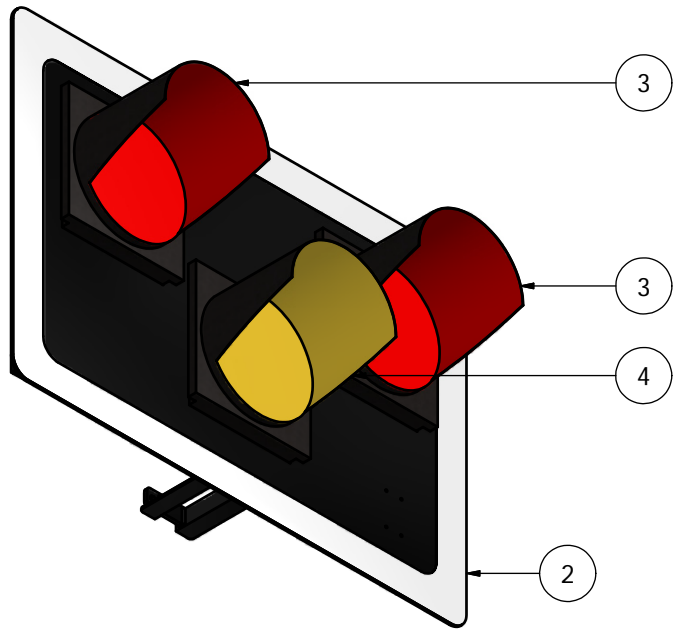

Designed by F. Foley	Checked by G. O'Connell	Approved by F. Foley	Date 23/02/2016	Date 23/02/2016
			Standard Road Traffic Lights Assembly	
			Drawing Number 151A0121D	Edition 0

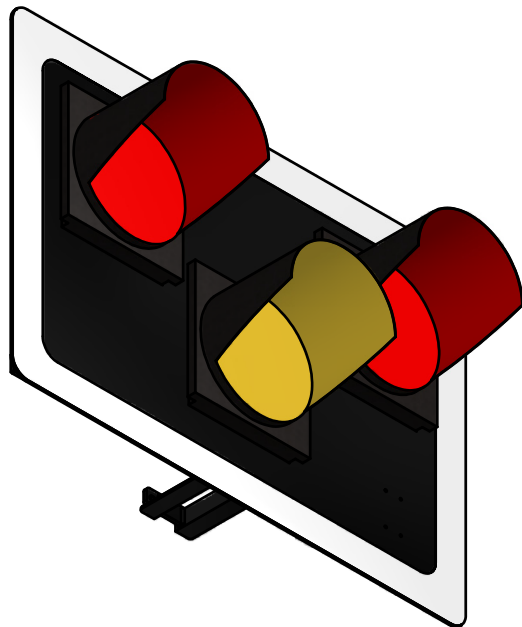
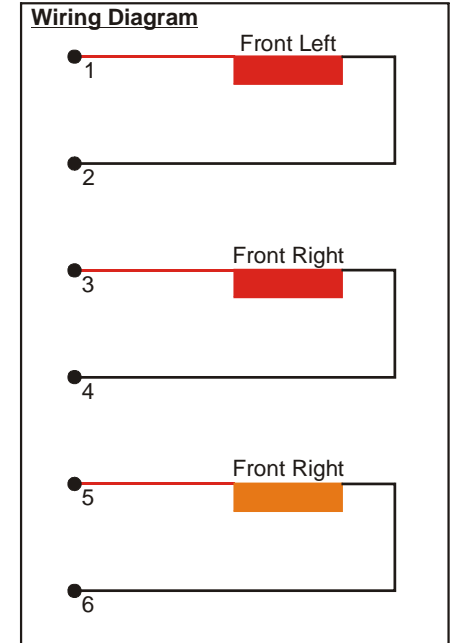
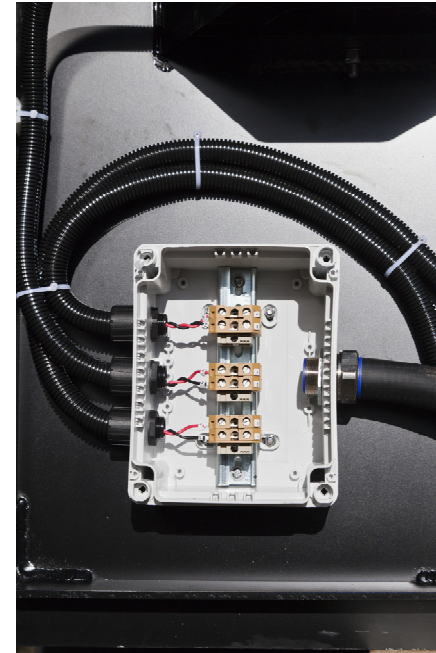
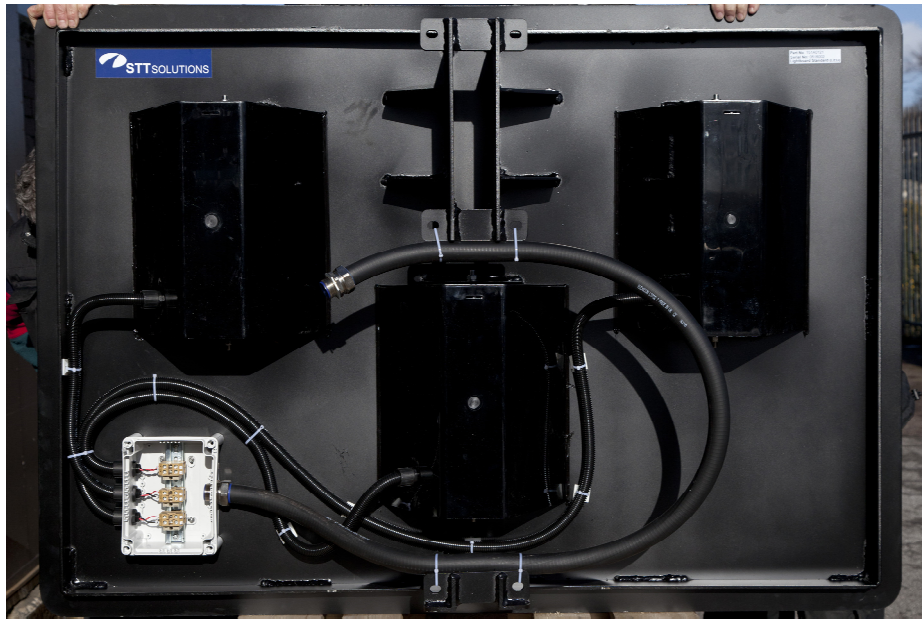

Designed by F. Foley	Checked by G. O'Connell	Approved by F. Foley	Date 23/02/2016	Date 23/02/2016
			Standard Road Traffic Lights Assembly	
			Drawing Number 151A0121D	Edition 0